

外部

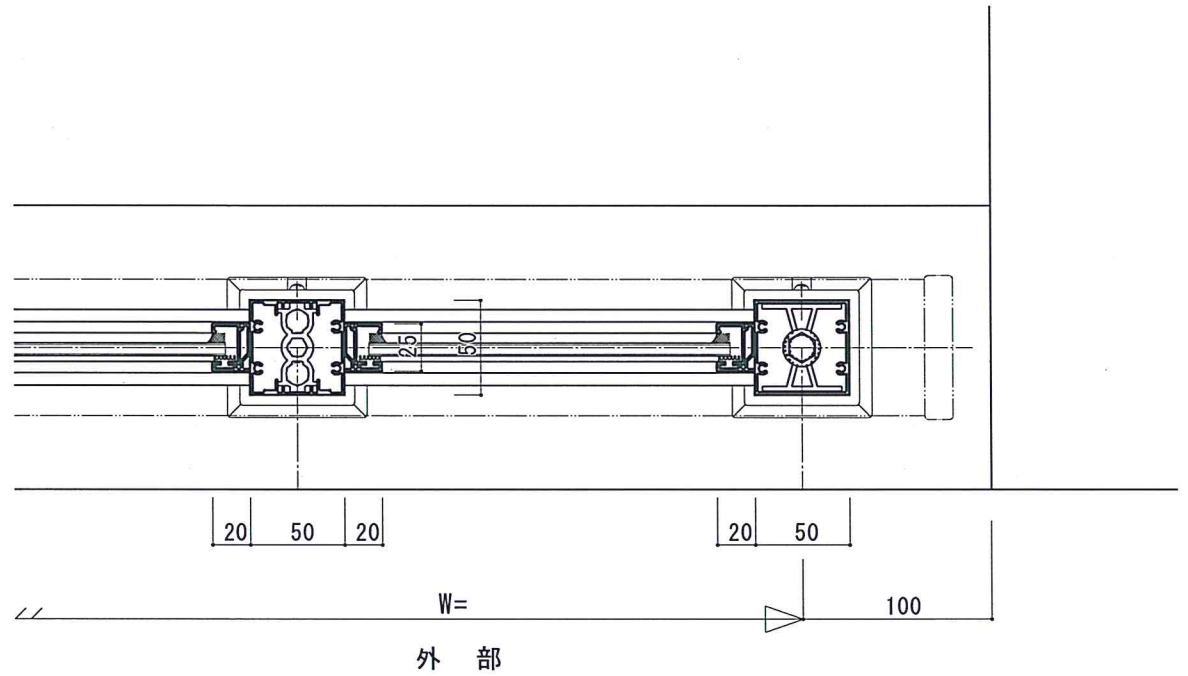

日付	備考	株式会社 松尾アルミニウム工業 設計 施工	受領印	工事名	縮尺	作 図	照 査	図 番
					1			

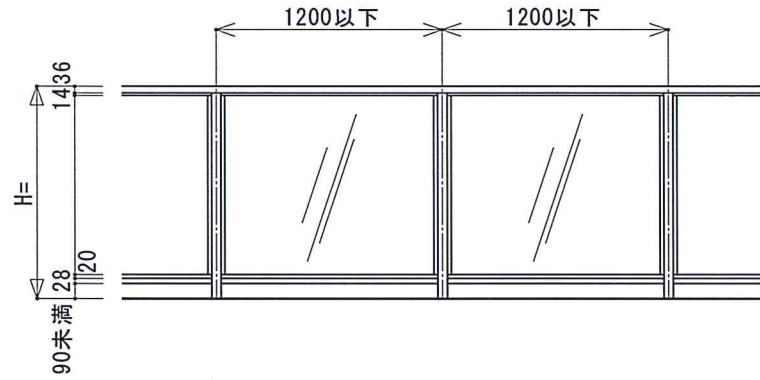
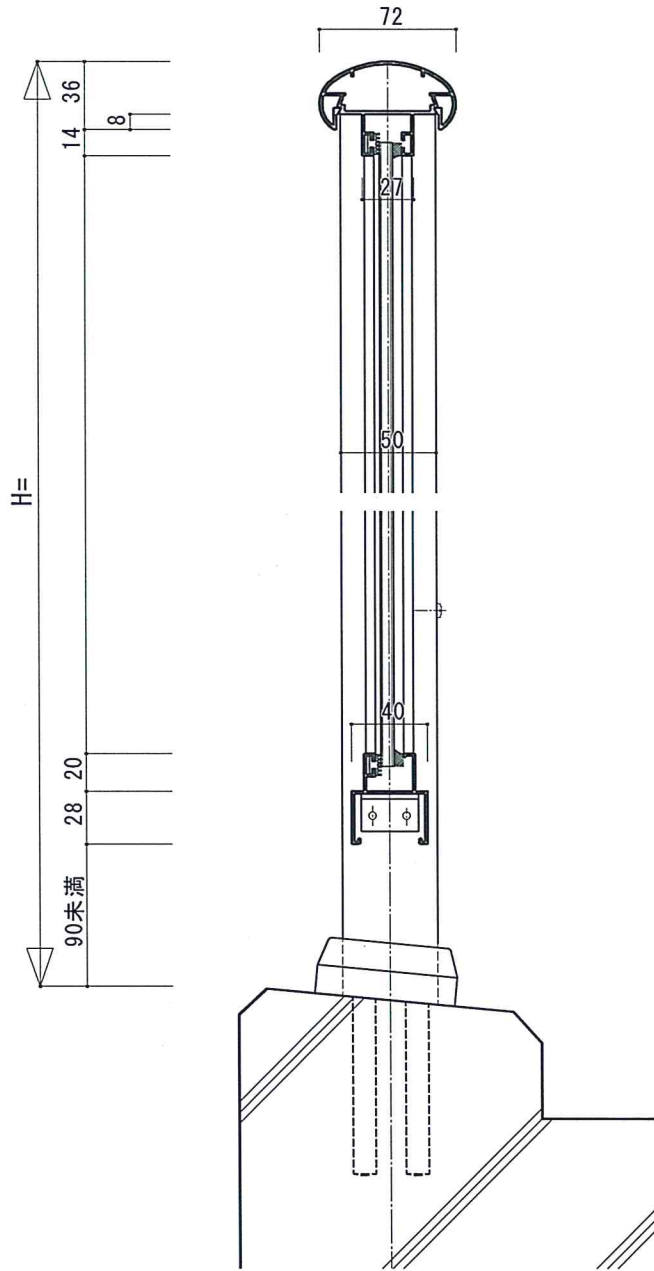

外部

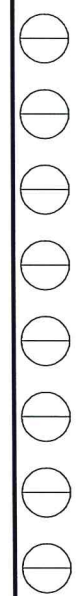
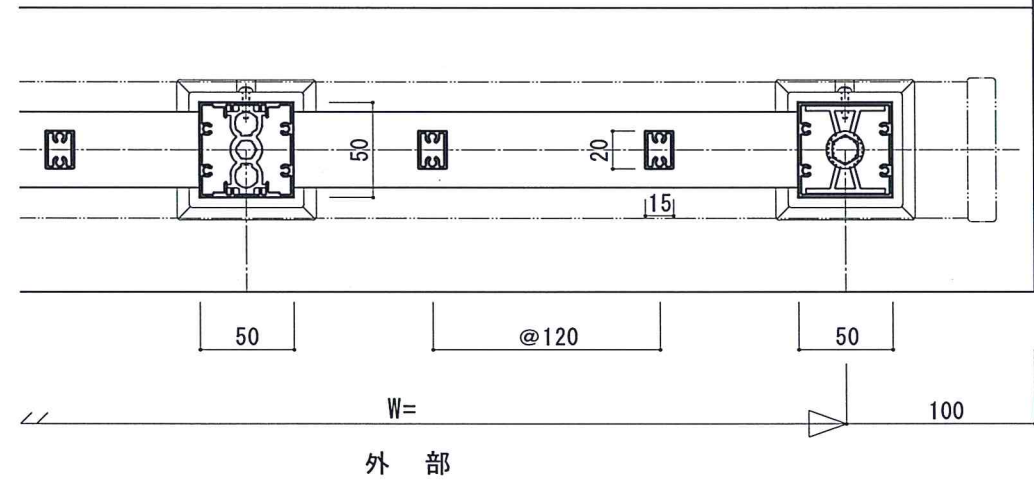
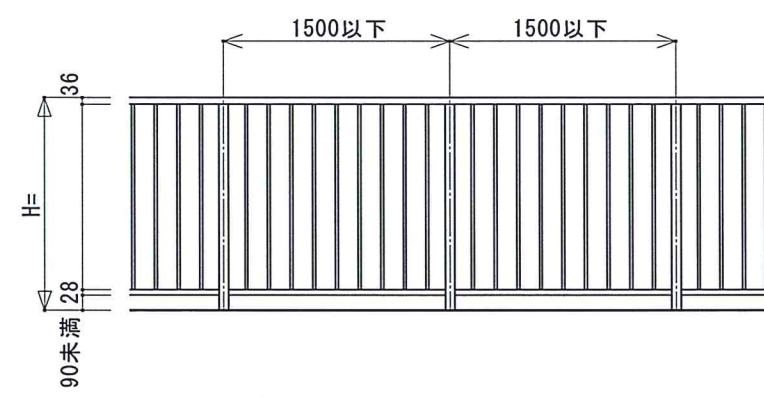
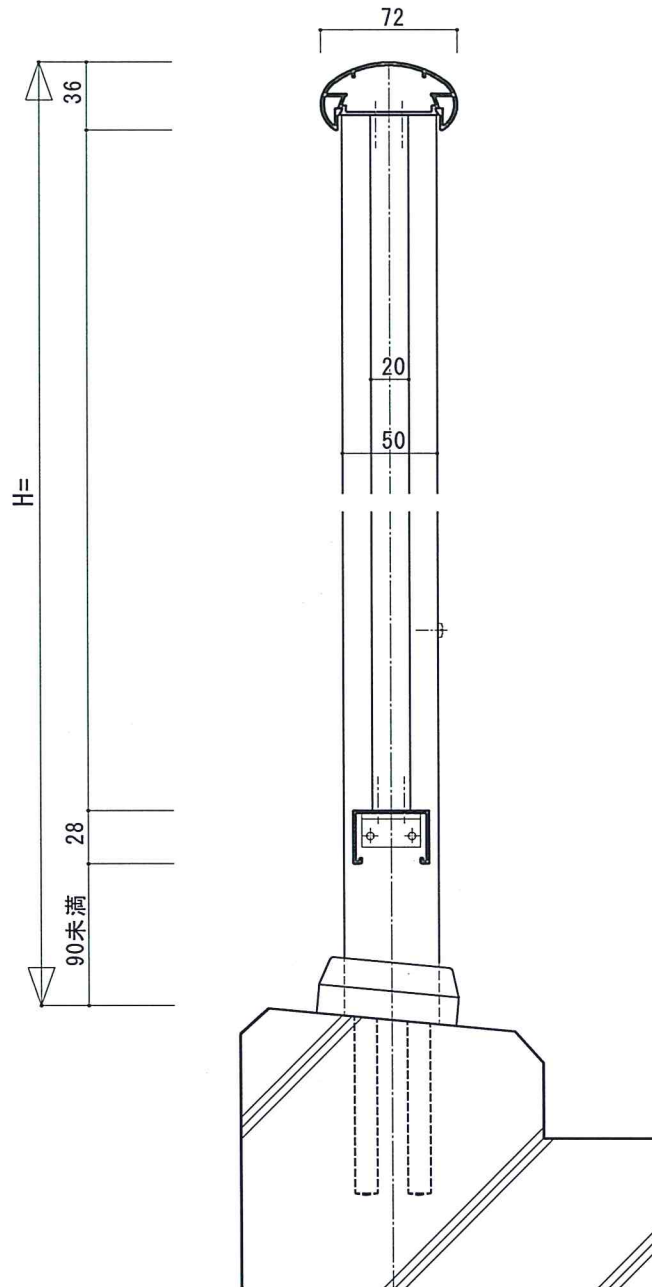

日付	備考	設計 施工	受領印	工事名	縮尺 1/1	作 図	照 査	図 番